



Assembly Instructions: 3 sheets Number of parts: 15

Warning for parents: This papercraft involves using glue, scissors, and other utensils and materials that may be dangerous to young children. Please work somewhere out of reach of young children.

HOW TO PLAY

There are 9 different blocks. Match the pictures and arrange them neatly in the box. What kind of animals can you make?

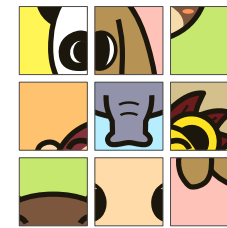

(Blocks)

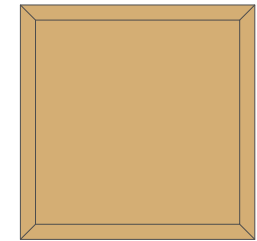

(Box)

Look at the picture on the right. There is a panda, and-- what's that?? Somebody's made something silly! Why don't you try making your favorite animal? If you have trouble, look at the pictures for help.

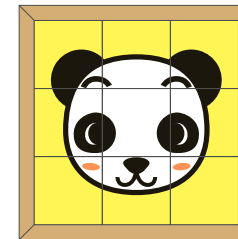

(Panda)

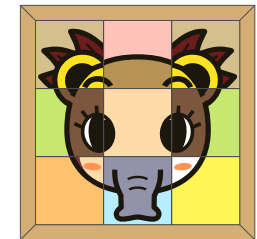

(???)

HOW TO MAKE

*Be careful not to hurt yourself when using scissors, glue etc.

*If you have trouble, ask an adult for help.

YOU WILL NEED: scissors, glue

NOTATION KEY: Follow the picture instructions below

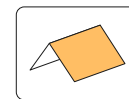

----- Mountain fold

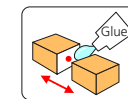

● Glue tab

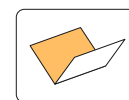

- - - - - Valley fold



⇨ Insert

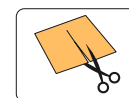

——— Scissors line

HOW TO ASSEMBLE THE BOX

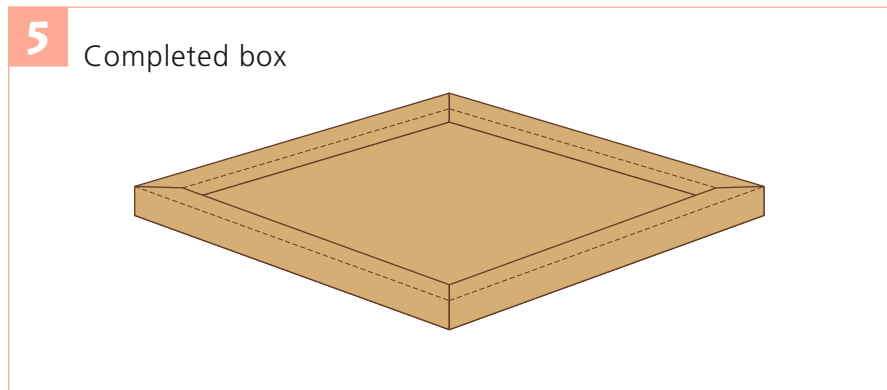
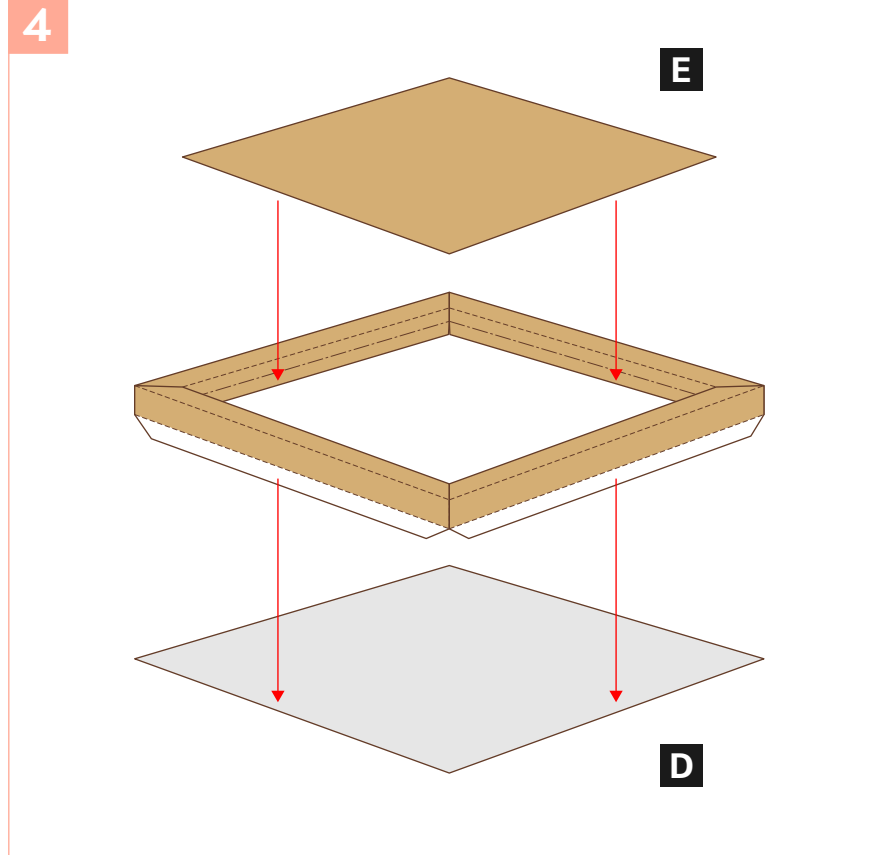
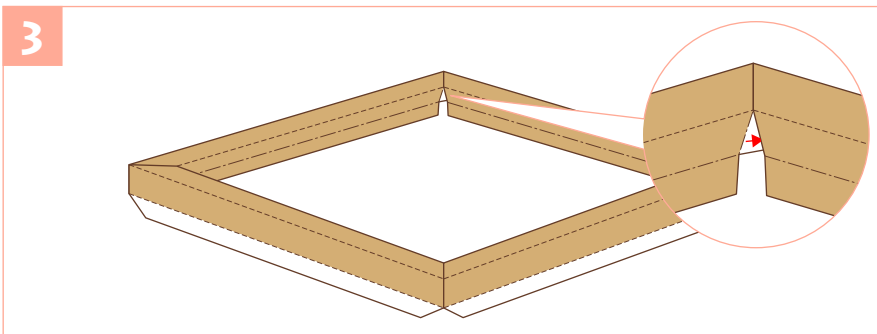
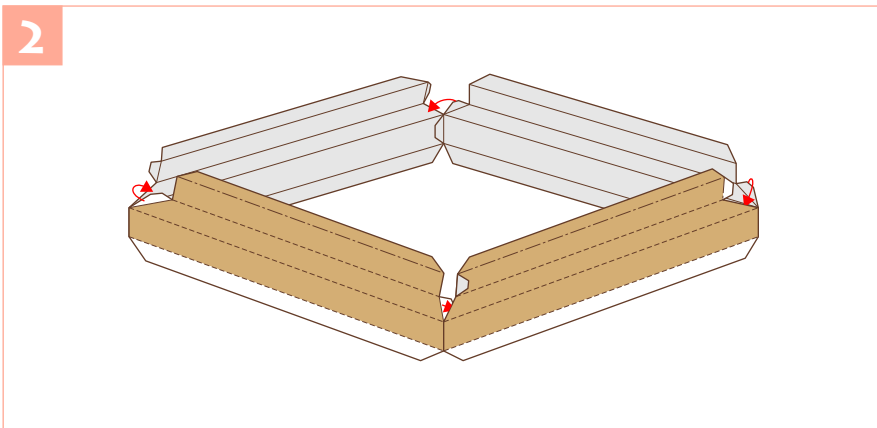
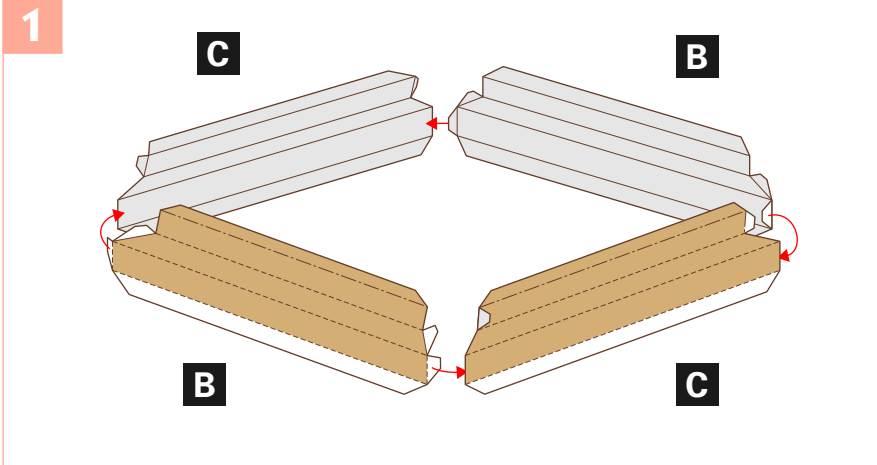

HOW TO ASSEMBLE THE BLOCKS

1

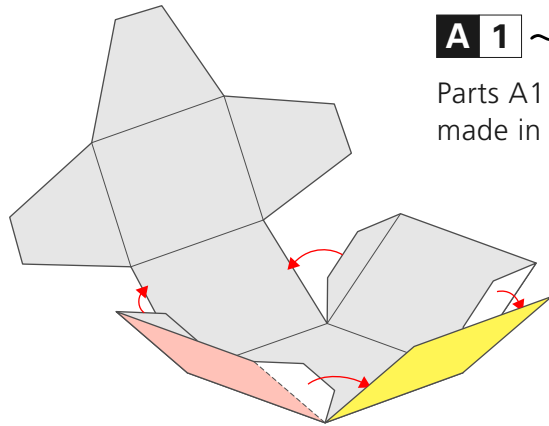

A 1 ~ **A 9**

Parts A1 to A9 are made in the same way.

2

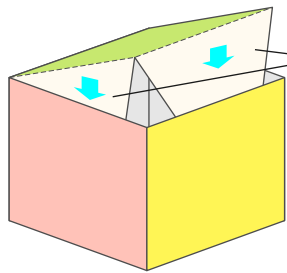

Insert the flaps without adding any glue.

3

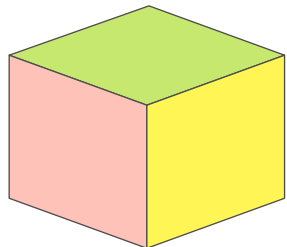

Completed block

COMPLETE

1

Assembly of the box and blocks are now complete.

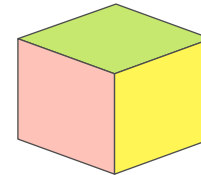
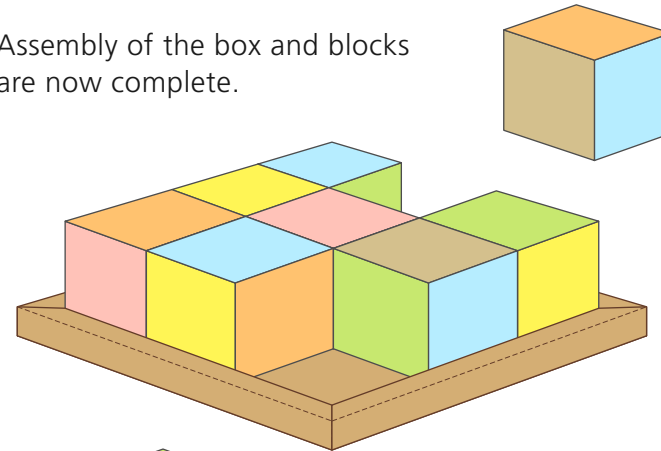

There are 9 blocks altogether. Try putting them in the box.

2

Look at the "How to Play" section on page 1, and have fun putting the faces together.

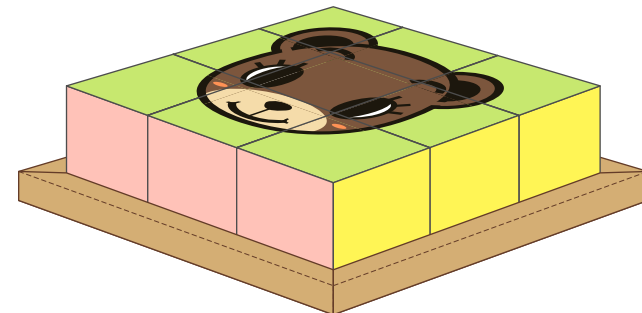



■ Pattern: 14 sheets
 ■ Number of parts: 15



Warning for parents: This papercraft involves using glue, scissors, and other utensils and materials that may be dangerous to young children. Please work somewhere out of reach of young children.

HOW TO PLAY

There are 9 different blocks. Match the pictures and arrange them neatly in the box. What kind of animals can you make?



(Blocks)

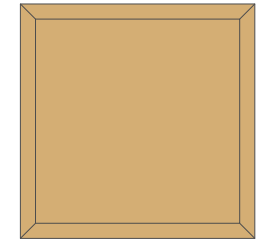

(Box)

Look at the picture on the right. There is a panda, and-- what's that?? Somebody's made something silly! Why don't you try making your favorite animal? If you have trouble, look at the pictures for help.

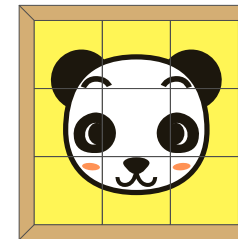

(Panda)

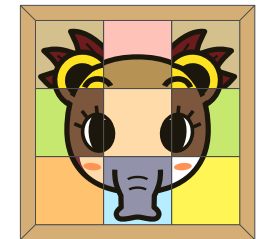

(??)

PICTURES FOR HELP



(Lion)

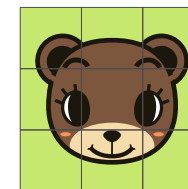

(Bear)

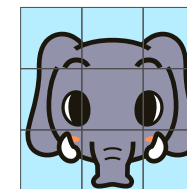

(Elephant)

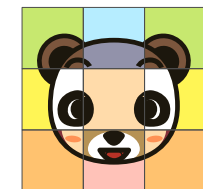

(??)

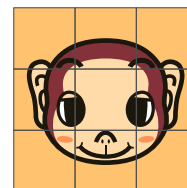

(Monkey)



(Panda)

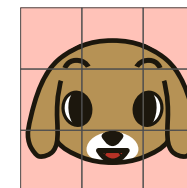

(Dog)

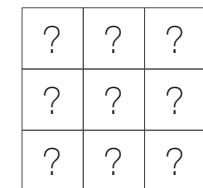

(Try making)

A 1

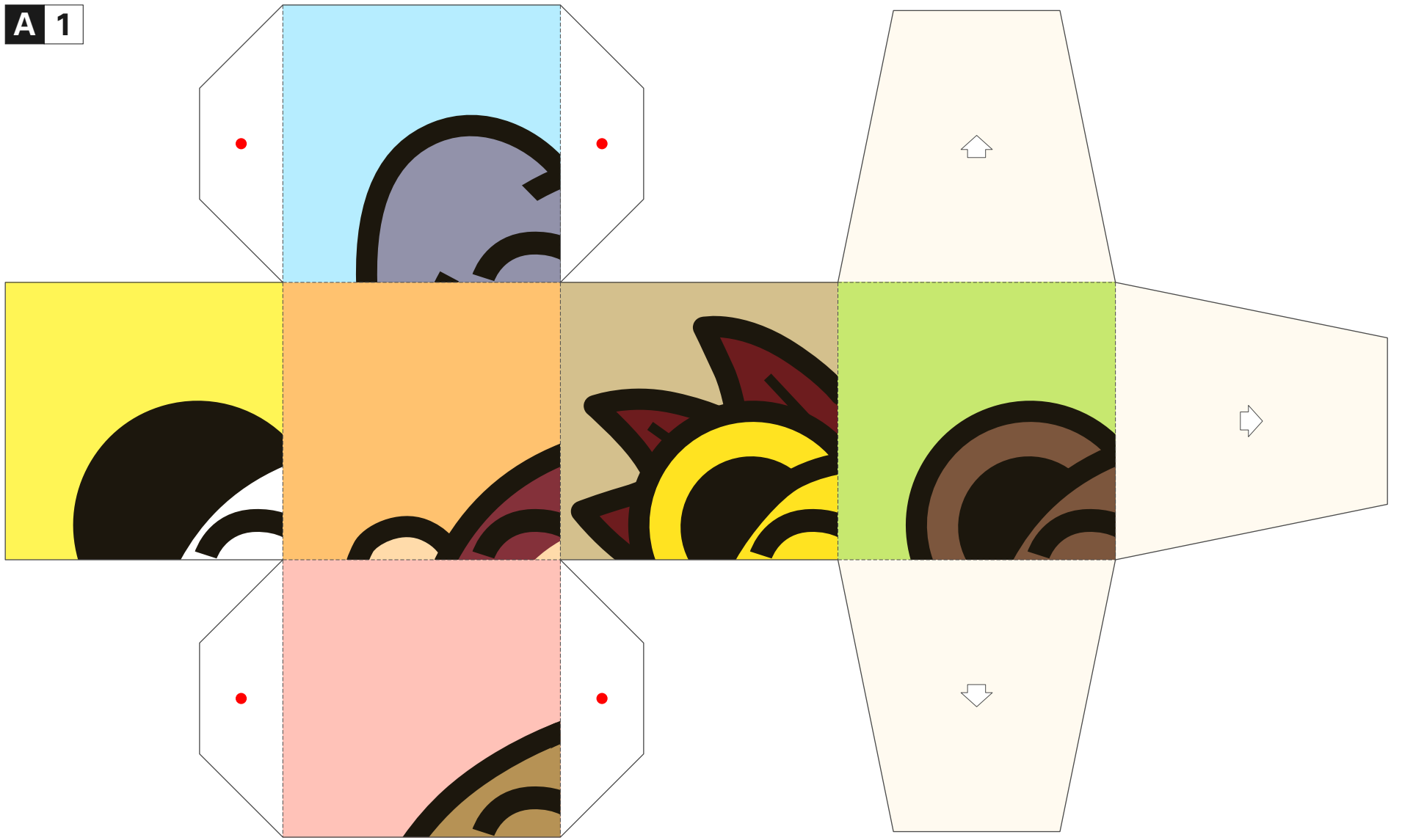

A 2

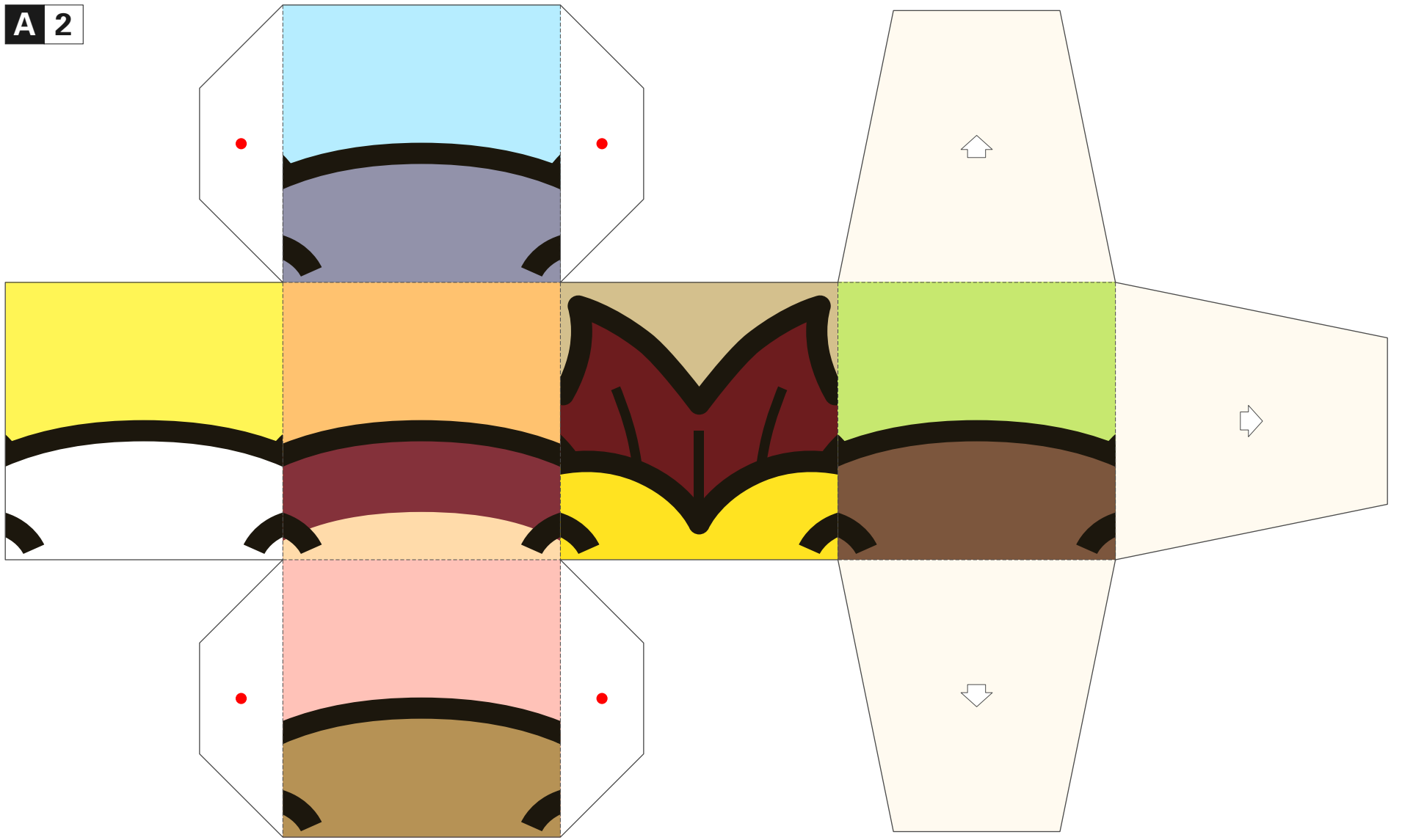

A 3

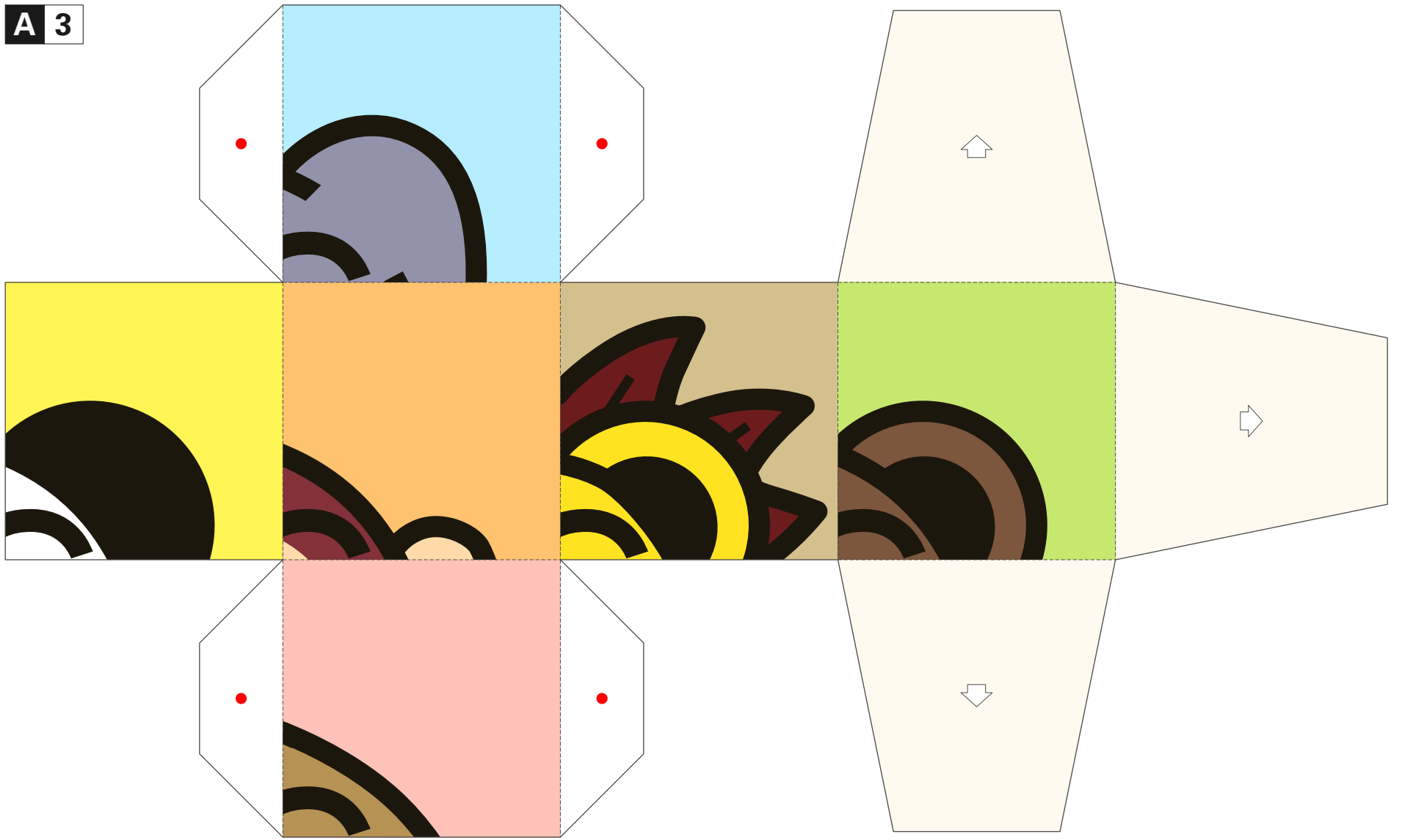

A 4

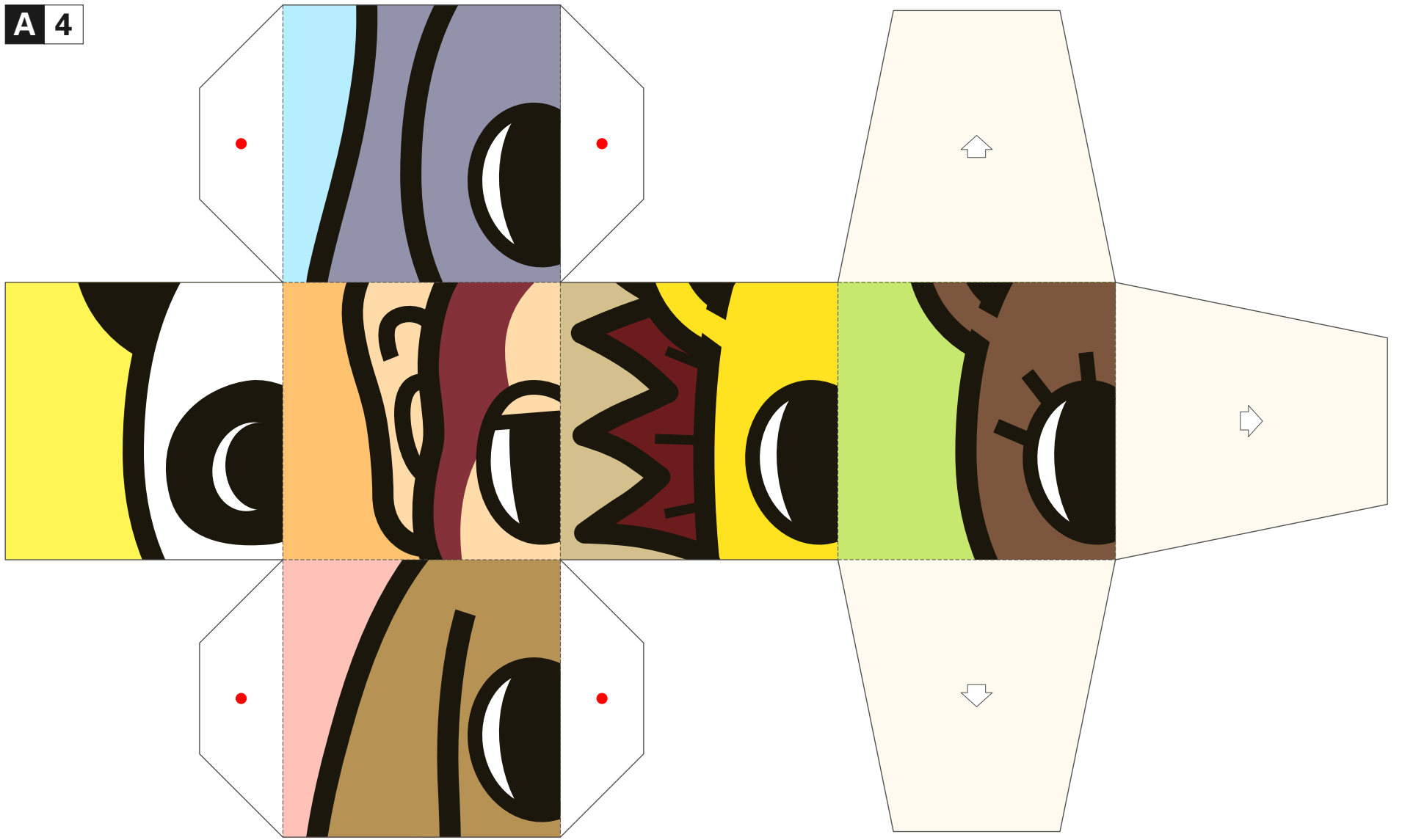

A 5

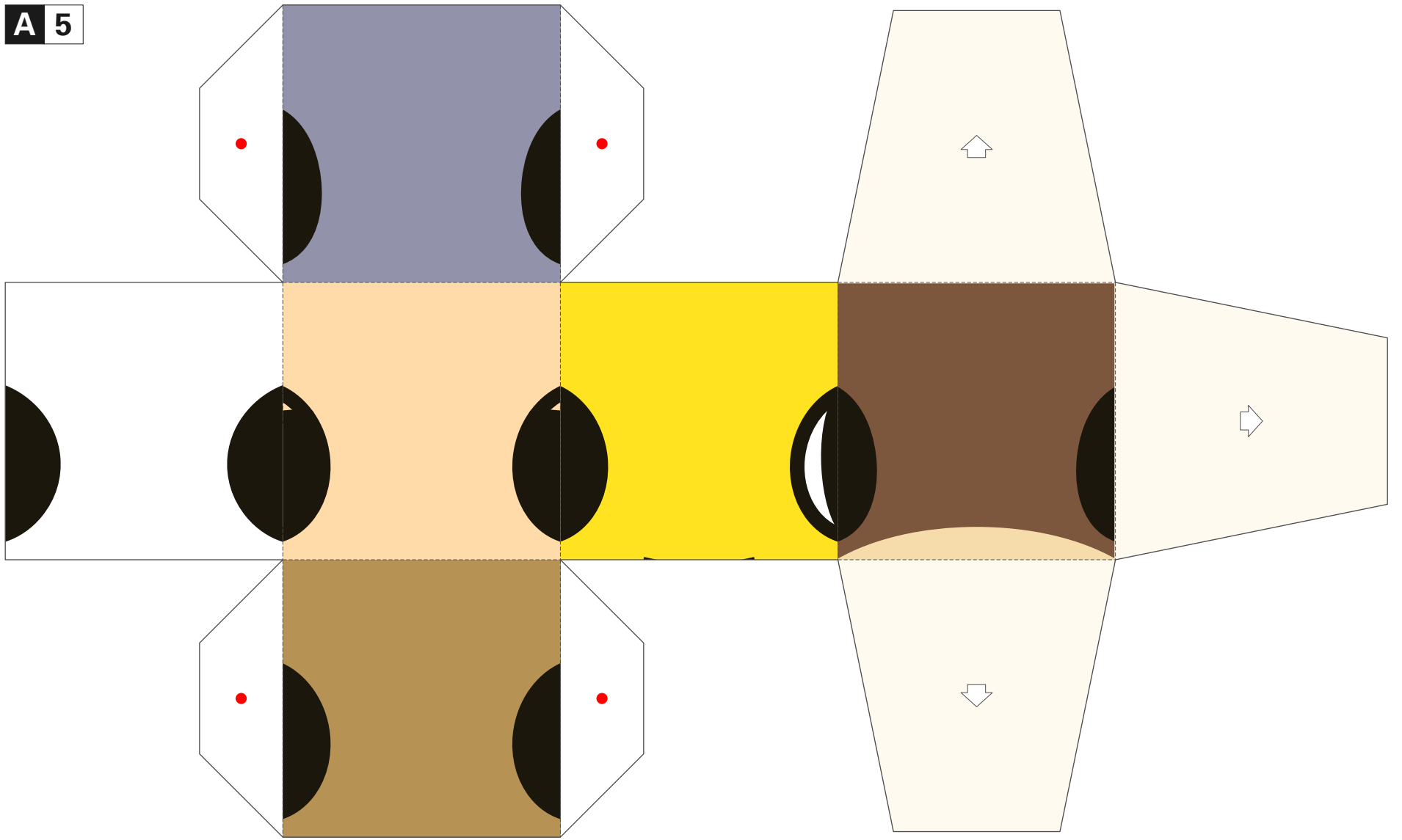

A 6

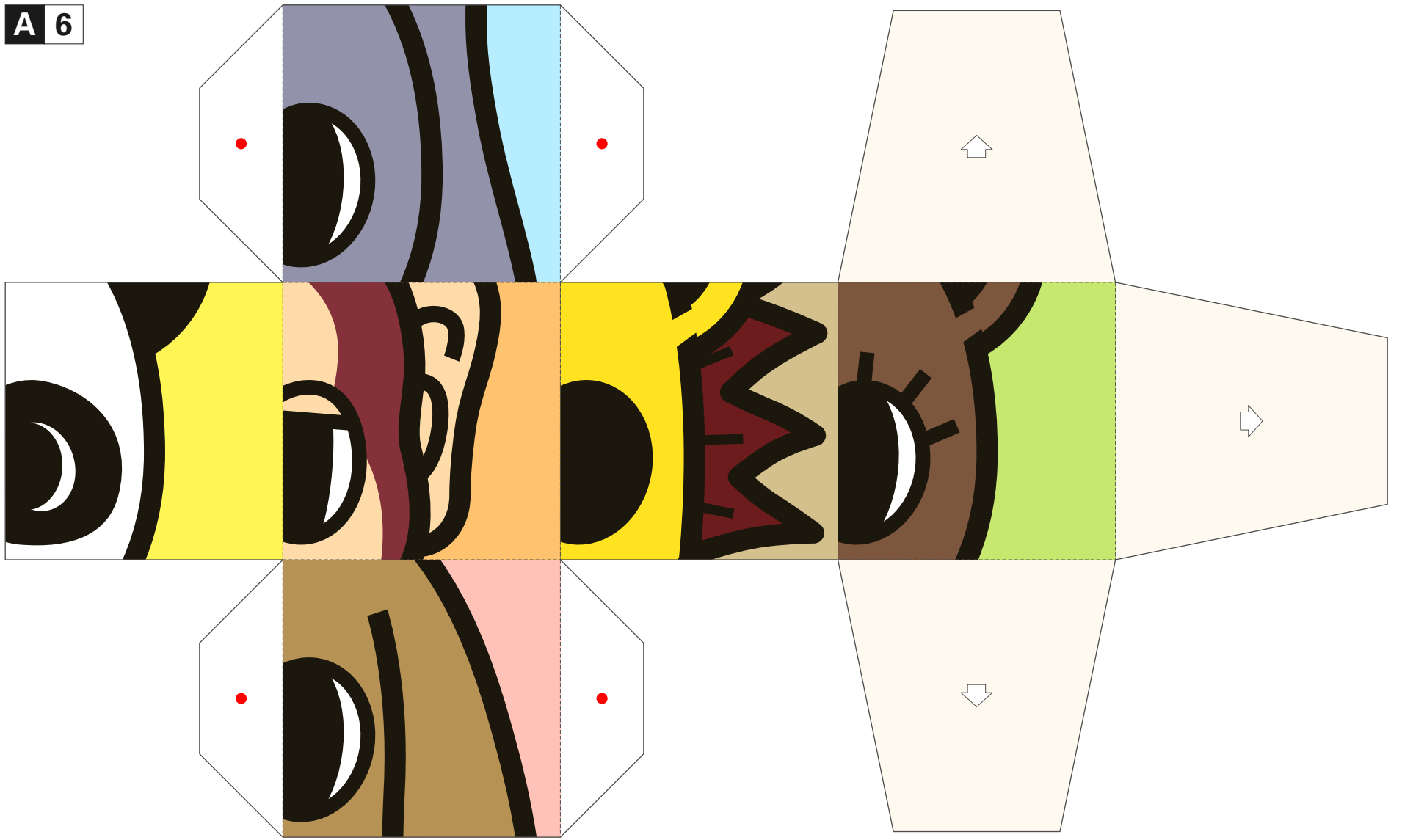

A 7

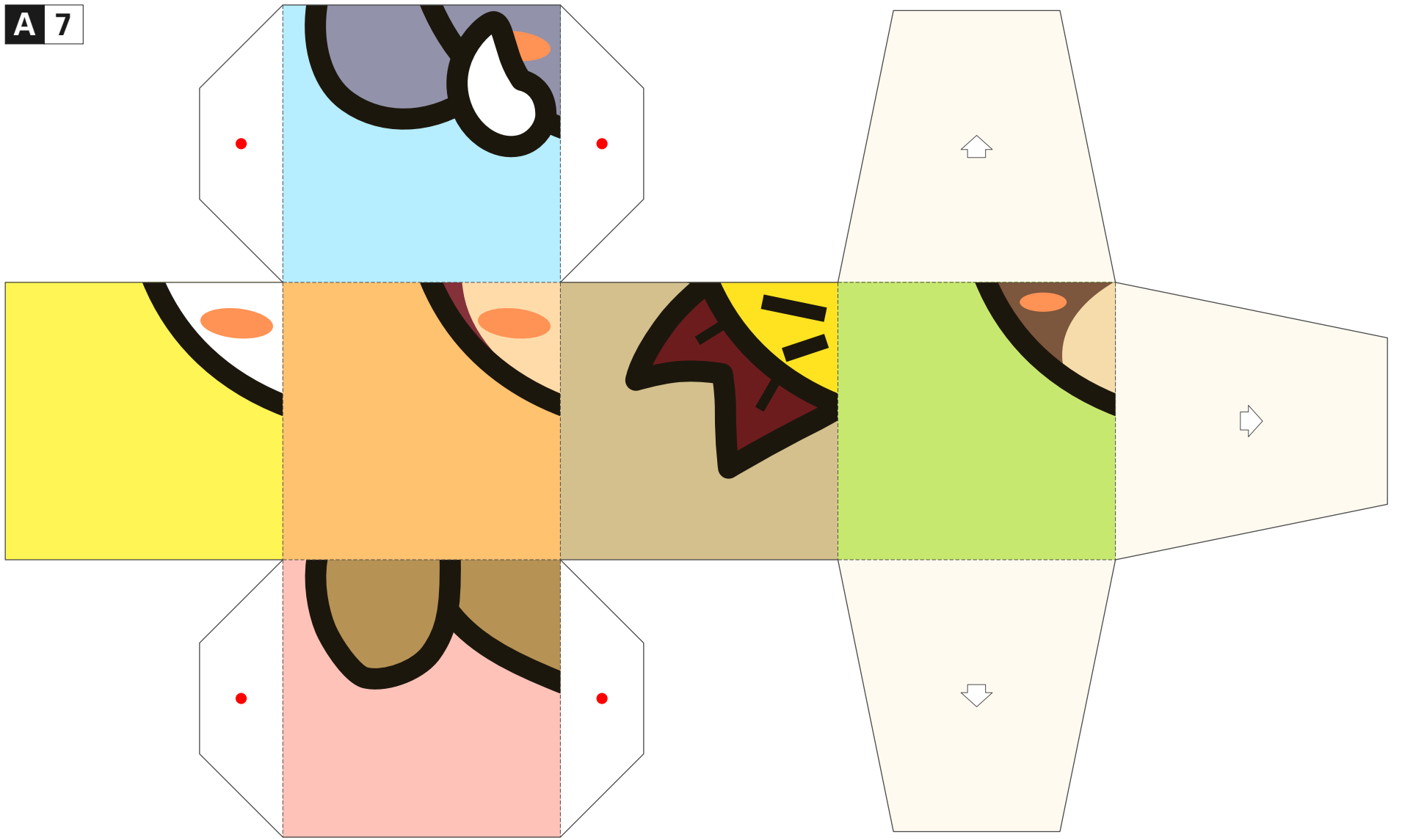

A 8

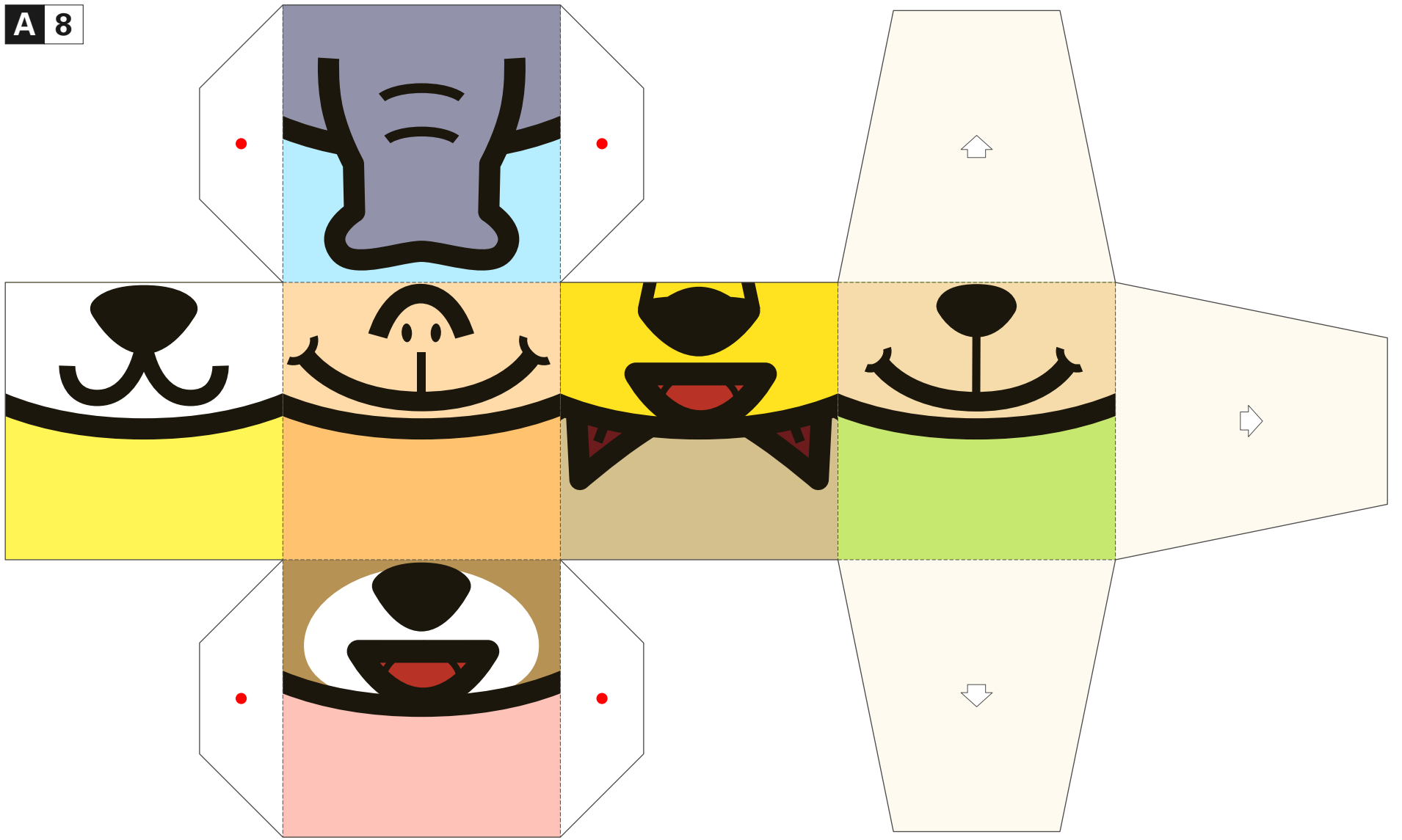

A 9

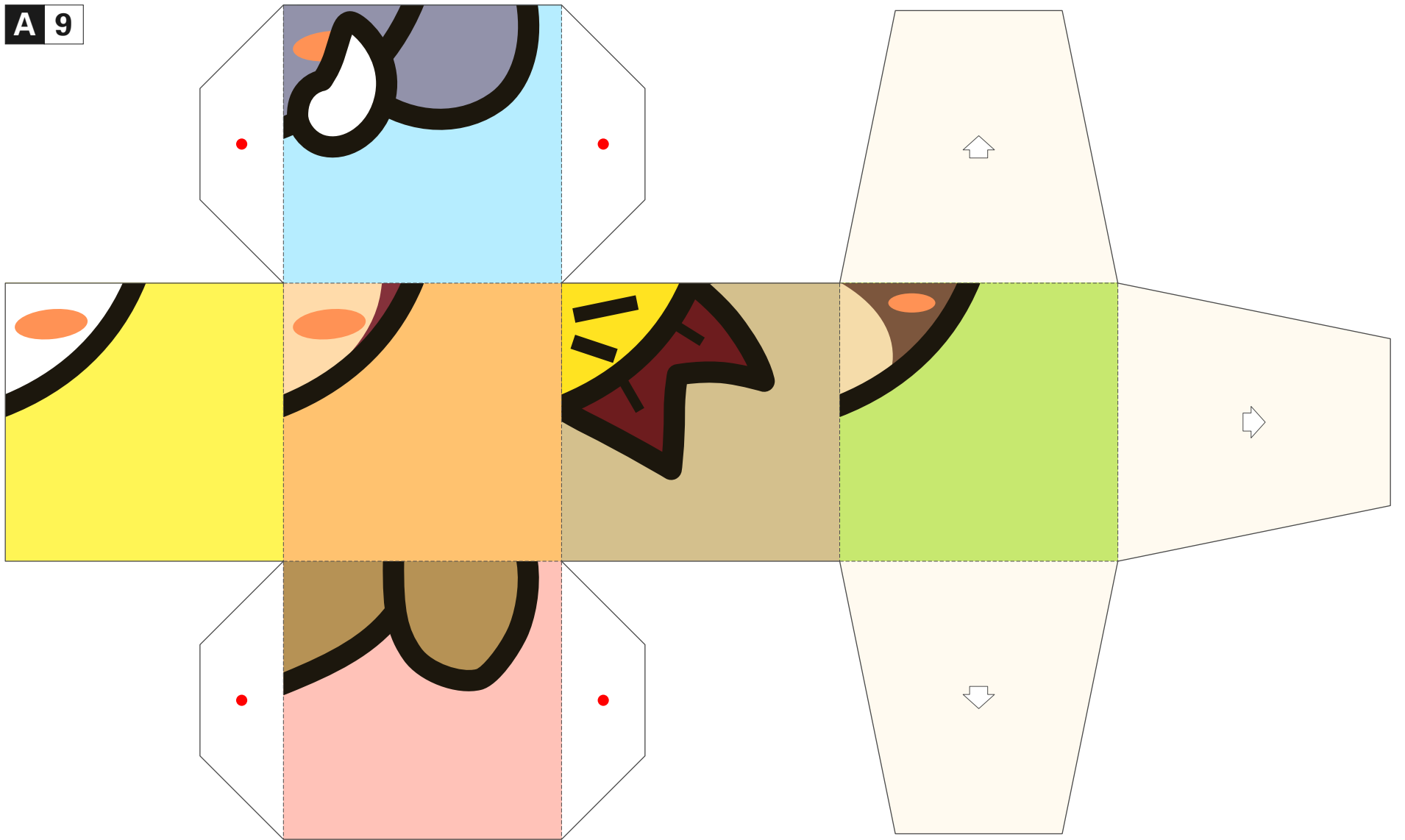

B

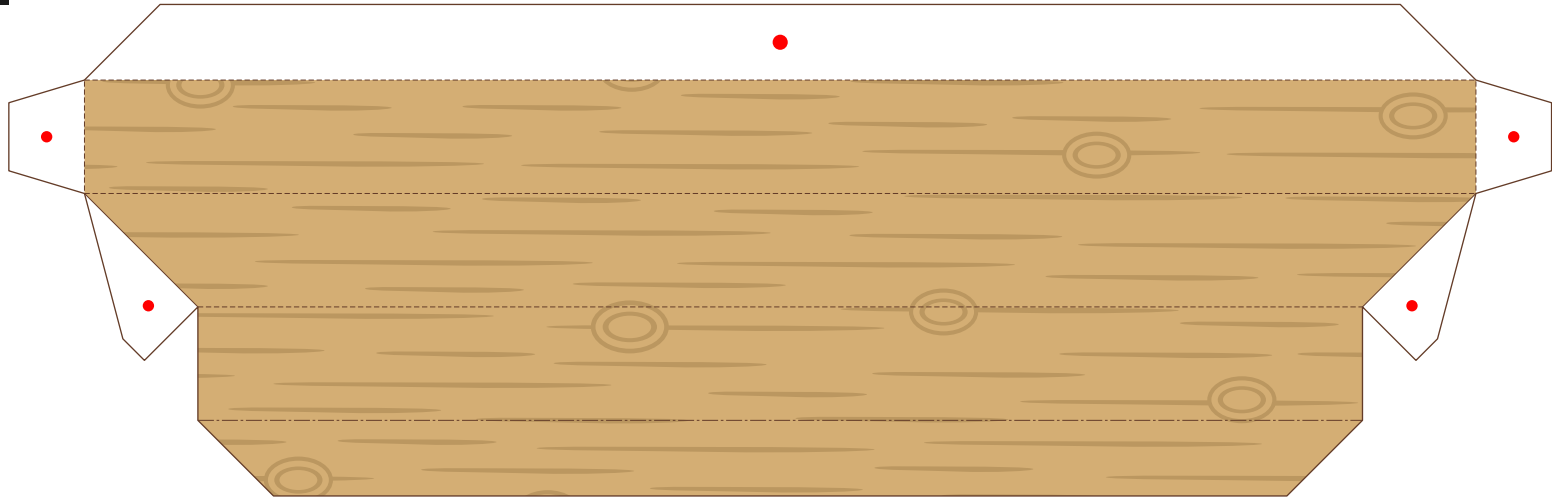

B

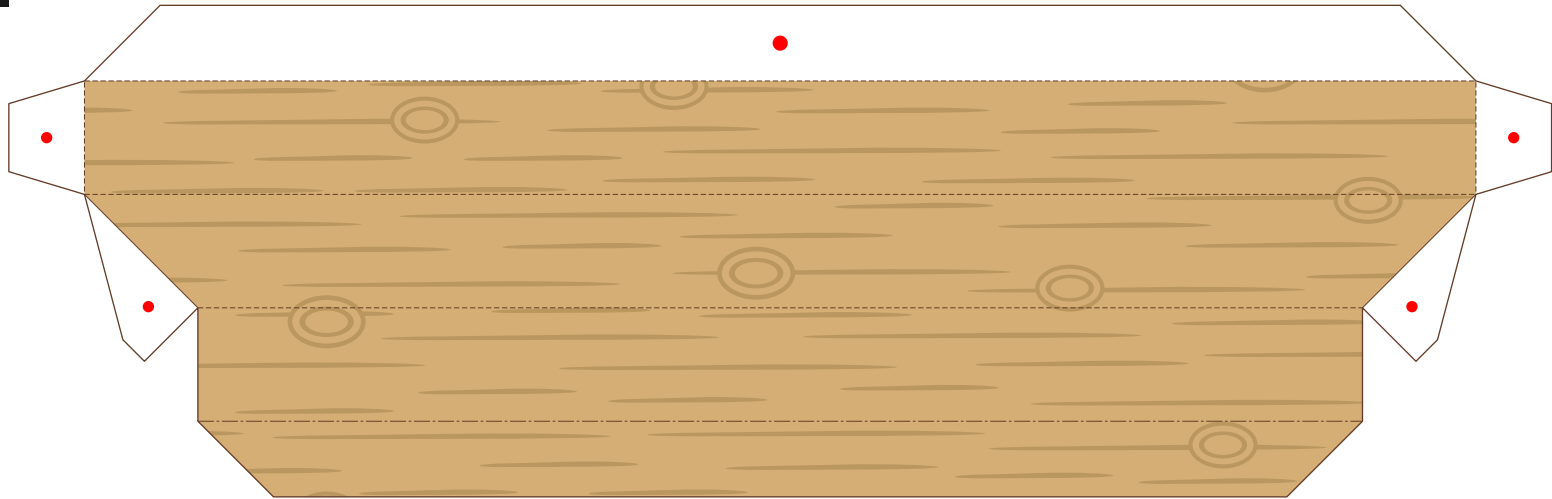

C

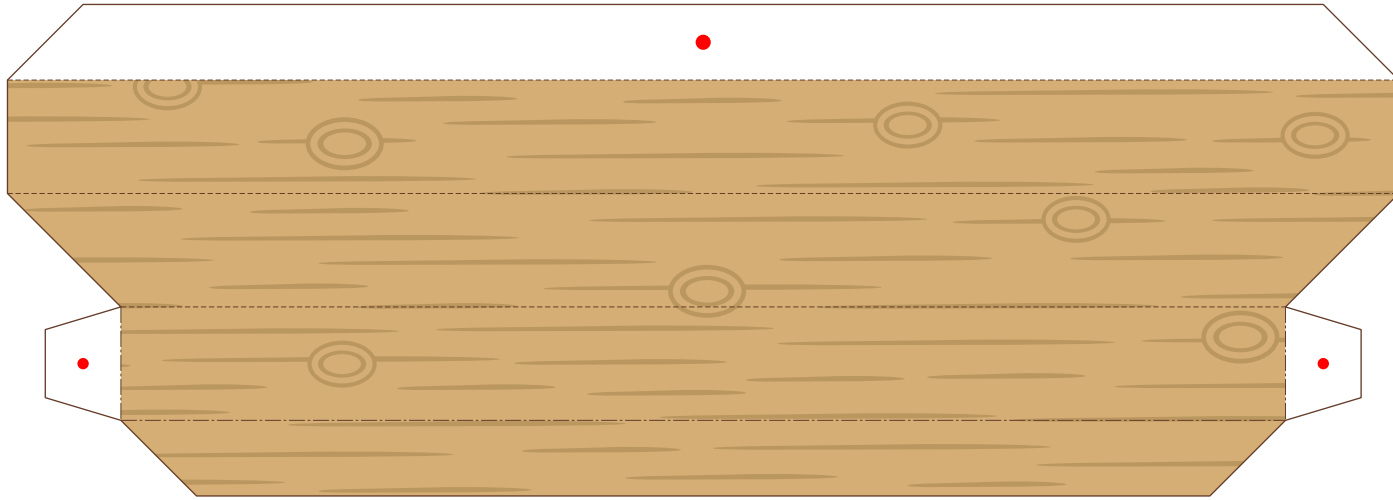

C

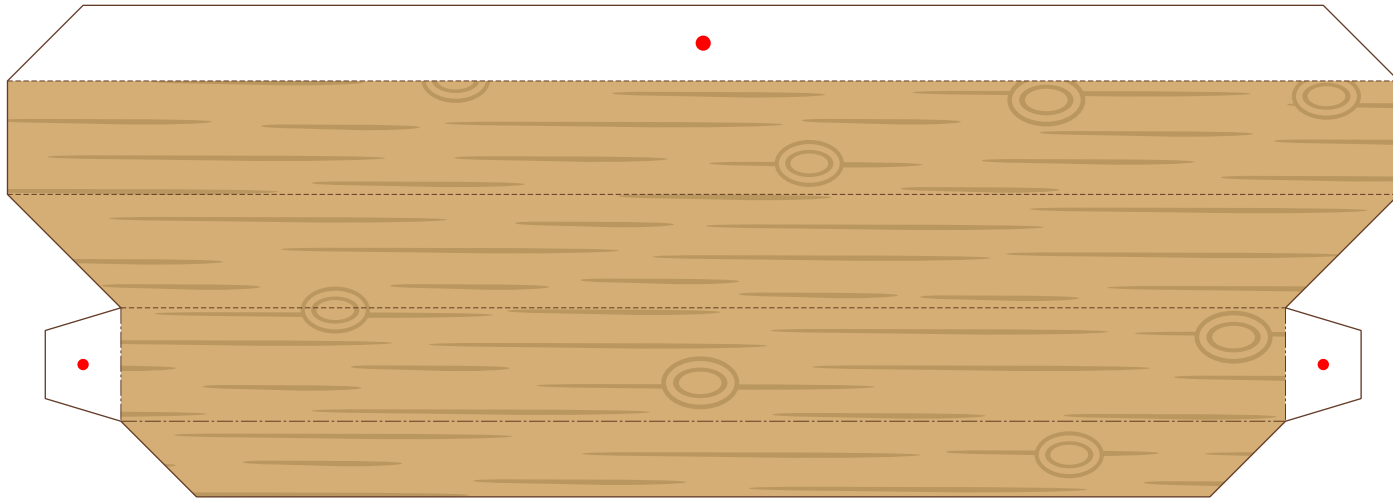

D

PICTURES FOR HELP

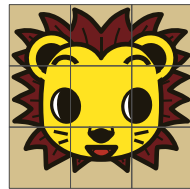

(Lion)



(Bear)

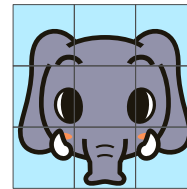

(Elephant)



(? ?)

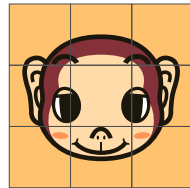

(Monkey)

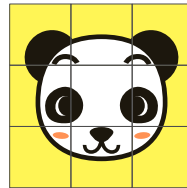

(Panda)

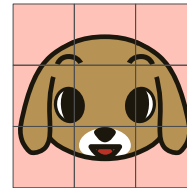

(Dog)

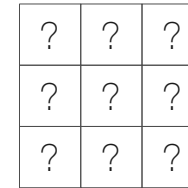

(Try making)

HOW TO PLAY: The 9 blocks have 6 different animals' faces on them. Match the pictures and arrange them neatly in the box. What kind of animals can you make? Why not mix up the blocks and try creating your own original animal?

E

